

Article number: 20278B25MZ2BL

Description: E+G Swivel clamp connector
GN278-B25-MZ-2-BL

Measures

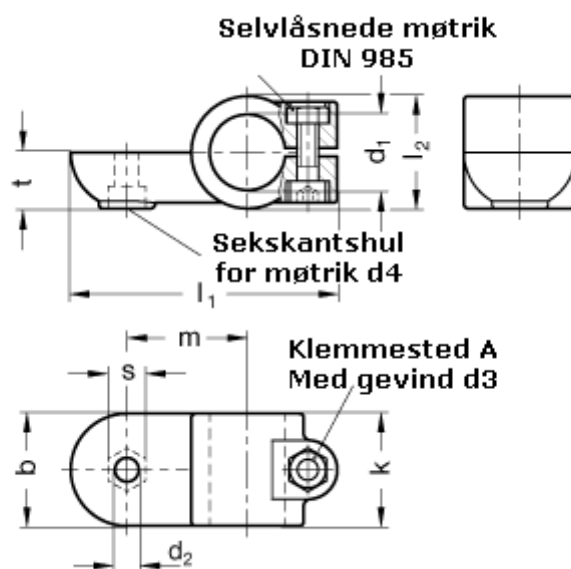

$b = 40$	$m = 43$
$d_1 = B25$	$s = 13.0$
$d_2 = 8.5$	$t = 20.0$
$d_3 = M 8$	
$d_4 = M 8$	
$k = 40$	
$l_1 = 95$	
$l_2 = 40$	